

GROVE®

GMK5115

preliminary product guide

features

- 115 USt (100 t) capacity
- 38-197 ft (11.7-60 m) 7-section full power boom
- 33-56 ft (10-17 m) bifold lattice swingaway, hydraulic luffing or manual offset
- 11 ft (3.3 m) 3-sheave heavy-duty jib, hydraulic luffing integrated in swingaway
- 59,700 lb (27 100 kg) counterweight with hydraulic removal system
- 510 hp (380 kW) Mercedes OM 502 LA 8 cylinder turbo-charged diesel engine. Daimler Chrysler, 16 speed G240-16 transmission
- Patented TWIN-LOCK™ boom pinning system
- Independent hydro-pneumatic MEGATRAK™ suspension
- All wheel steering

contents

Features	2
Specifications	3
Dimensions	5
Counterweight Dimensions	6
Travel Proposal	7
Working Range Main Boom	8
Main Boom Charts	9
Load Charts	10
Working Range Manual Offset Swingaway	11
Working Range Hydraulic Offset Swingaway	12
Hydraulic Offset Swingaway Charts	13
Manual Offset Swingaway Charts	14



All Terrain Crane

features

2



Mercedes-Benz OM 502 LA
510 bhp (380 kW) @ 1800 rpm
1770 ft./lb. torque (2400 Nm) @ 1200 rpm

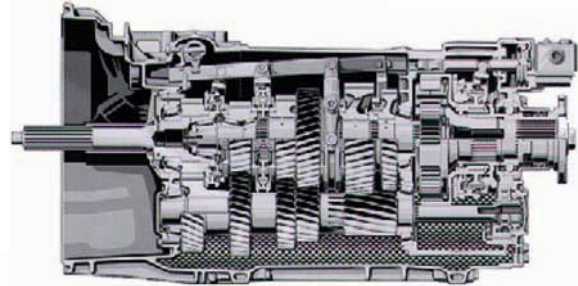

Daimler Chrysler
16 speed G240-16

TWIN-LOCK™

Boom pinning mechanism automatically pins the sections in position using two horizontal large diameter boom pins. The proven “U”-shaped MEGAFORM™ design provides a natural cradling position for boom sections which eliminates stiffeners, reducing weight and increasing capacity. Large wear pads provide superior boom alignment when telescoping and allows an excellent transition of weights between sections.



LUFFING BI-FOLD SWINGAWAY

Hydraulically offset lattice bi-fold swingaway lets the operator set the offset from 0°-40° while under load, from the superstructure cab; 11 ft (3.3 m) 3-sheave heavy duty jib, hydraulic luffing integrated in swingaway.



MEGATRAK™

Independent suspension and all wheel steer system allows wheels to remain on the ground at all times so stresses and weight are not continually transferred between axles.

GMK5115

specifications

3

Superstructure



Boom

38 ft. - 197 ft. (11.7 m - 60 m) seven-section, full power boom with patented TWIN-LOCK™ boom pinning system. Maximum tip height: 207 ft. (63 m).



Boom Nose

Seven nylatron sheaves, mounted on heavy duty tapered roller bearings with removable pin-type rope guards. Quick reeve boom nose. Removable auxiliary boom nose with removable pin type rope guard.



Boom Elevation

Single lift cylinder with safety valve provides boom angle from -1.5° to +82°.



Hydraulically Offsettable Lattice Extension

33 ft. - 56 ft. (10 m - 17 m) bifold lattice swingaway extension **hydraulically offsettable** and luffing under load: 0° - 40°. Controlled from the crane cab. Maximum tip height: 263 ft. (80 m)



* Offsettable Lattice Extension

33 ft. - 56 ft. (10 m - 17 m) bifold lattice swingaway extension manually offset: 0°, 20° or 40°. Maximum tip height: 263 ft. (80 m)



Lattice Extension Inserts

One 16 ft. (5 m) insert for use with lattice swingaway extension. Increases extension length to 72 ft. (22 m).



Load Moment & Anti-Two Block System

Load moment and anti-two block system with audio/visual warning and control lever lockout provides electronic display of boom angle, length, radius, tip height, relative load moment, maximum permissible load, load indication and warning of impending two-block condition.



Cab

All aluminum construction cab with acoustical lining, tinted safety glass, adjustable operator's seat with suspension, opening windows in side and cab rear, hinged front window with wiper, sunvisor and window shade. Other features include hot water heater, armrest integrated crane controls, and ergonomically arranged instrumentation.



Crane Control System

Full electronic control of all crane movements using electrical control levers with automatic reset to zero. Controls are integrated with the LMI and engine management system by CAN-BUS. ECOS system with graphic display.



Swing

Two planetary gears with axial piston motors. Infinitely variable to 1.9 rpm. Holding and service brake.



Counterweight

59,700 lbs. (27 100 kg) consisting of various sections with hydraulic installation/removal system. Controlled from the superstructure cab.



Engine

Mercedes-Benz OM 904 LA diesel, 4 cylinders, water cooled, turbocharged with 148 bhp (110 kW) @ 2200 rpm. Max torque: 428 ft/lb. (580 Nm) at 1200 rpm. Engine emission: EUROMOT/EPA/CARB (non road).



Hydraulic System

2 separate circuits, 1 axial piston variable displacement pump (load sensing) with electronic power limiting control and 1 gear pump for swing. Dual thermostatically controlled oil coolers keep oil at optimum operating temperature. Tank capacity: 158 gal. (600 l)



Hoist

Main and auxiliary hoists are powered by axial piston motor with planetary gear and brake. "Thumb-thumper" hoist drum rotation indicator alerts operator of hoist movement.

	Main	Auxiliary
Line length:	837 ft. (255 m)	837 ft. (255 m)
Rope diameter:	17 mm	17 mm
Line speed:	394 ft./min. (120 m/min)	394 ft./min. (120 m/min)
Line pull:	12,589 lbs. (56 kN)	12,589 lbs. (56 kN)



Electrical System

24V system with three phase alternator, 28V/80A. 2 batteries, 12V/170 Ah.

*Optional Equipment

- *10.8 ft (3.3 m) 3-sheave integrated heavy duty jib.
- *Work light, mounted on top of base section.
- *Cab controlled work lights mounted to top of base section.
- *Stainless steel exhaust system with spark arrestor in lieu of standard.
- *Engine independent diesel cab heater, also serves as engine preheater including 24-hour timer.
- *Engine independent propane gas cab heater.
- *Stereo/radio CD player.
- *Outrigger pad load indicator with readout both in superstructure cab and carrier.
- *Air conditioning.
- *Working range limiter.
- *Boom mounted aircraft warning light.
- *Drive and steer control for superstructure.
- *EKS5 with graphic display.

*Denotes optional equipment

GMK5115

GROVE

specifications

4

Carrier



Chassis

Box type, torsion resistant frame is fabricated from high strength steel.



Outrigger System

Four hydraulic single stage outrigger beams with vertical cylinders and outrigger pads, 23.6" (600 mm) square. Outriggers can be set in 3 positions:

Full	- 24.6' (7.5 m)
Partial	- 22.0' (6.7 m)
	- 19.4' (5.9 m)
	- 16.7' (5.1 m)
Retracted	- 8.2' (2.5 m)

Independent horizontal and vertical movement controlled from each side of carrier. Electronic crane level indicators.



Engine

Mercedes-Benz OM 502 LA eight cylinder, water cooled, turbo-charged, with 510 bhp (380 kW) @ 1800 rpm. Max. torque 1,770 ft./lb. (2 400 Nm) @ 1200 rpm.

Engine emissions: EUROMOT/EPA/CARB (off road)
Compression and exhaust brakes.



Fuel Tank Capacity

106 gallons (400 L).



Transmission

Daimler Chrysler, 16 speed G240-16.



Drive/Steer

10X6X10



Axles

1st axle line – steer

2nd axle line – steer (additional drive)

3rd axle line – drive/steer (disconnects for highway travel
10x8x10 drive only)

4th axle line – drive/steer (connects for all wheel steer)

5th axle line – drive/steer

Drive axles with planetary hub reduction and center mounted differential-gearing. Inter-axle and cross axle differential locks.



Suspension

Exclusive MEGATRAK suspension. Independent hydro-pneumatic system acting on all wheels with hydraulic lockout. Suspension can be raised 6.5" (170 mm) or lowered 5" (130 mm) both longitudinally and transversely. Features an automatic leveling system for highway travel.



Tires

10 tires, 16.00R25



Steering

Dual circuit, hydraulic power assisted steering system. Transfer case mounted, ground driven emergency steering pump. Axles 1, 2, 3 and 5 steer on highway. Separate steering of the 4th and 5th axles for all wheel and crab steering, controlled by an electronic rocker switch.



Brakes

Service brakes: pneumatic dual circuit acting on all wheels, anti lock prevention.

Parking brake: pneumatically operated spring loaded brake acting on axle lines 2 and 5.

Air dryer.



Cab

Two-man construction with the following features: safety glass, driver and passenger seats with suspension, heated rear view mirrors, engine independent diesel cab heater, AC, complete instrumentation and driving controls.



Electrical System

24V system with three phase alternator, 28V/100A
2 batteries, 12V/170 Ah



Maximum Speed

53 mph (85 kph)



Gradeability (Theoretical)

72% - 14.00 tires

64% - 16.00/20.5 tires

Miscellaneous Standard Equipment

Work light; tool kit; fire extinguisher; auxiliary boom nose; radio/CD player in carrier cab, heated rear view mirrors, and cruise control.

Optional Equipment

*Stainless steel exhaust system with spark arrestor

*20.5R25 tires (vehicle width 10.2 ft., 3.1 m)

*10X8X10 drive/steer

*Electric driveline retarder

*Worklights for outriggers

*Steel outrigger floats

*Spare tire with carry bracket

*Outrigger pad load indicator

*Hinged bunk bed

*Denotes optional equipment

GMK5115

GROVE

dimensions

5

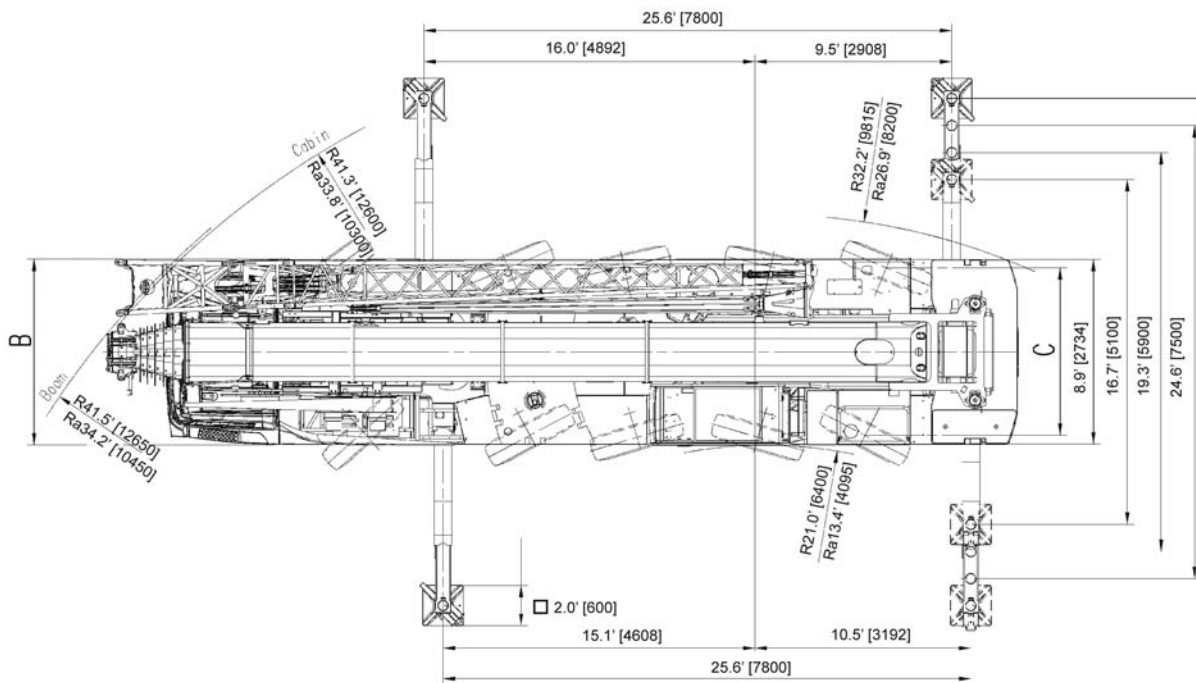
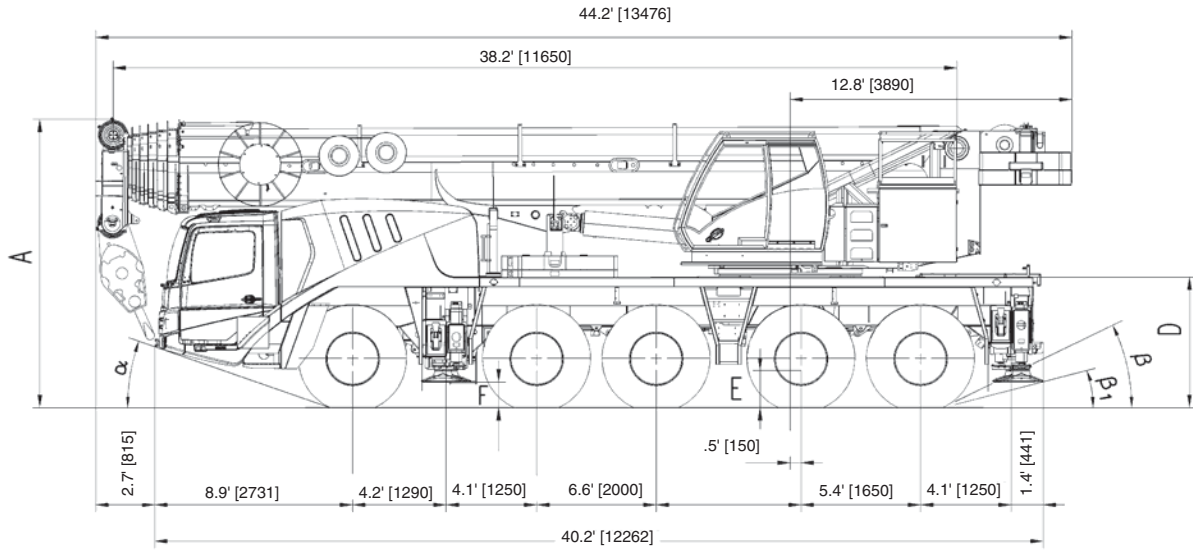

	A	A 5.1 in.* (130 mm)	B	C	D	E	F	α	β	β_1
14.00 R25	12.9 (3945)	12.5 (3815)	9.0 (2750)	7.7 (2338)	5.7 (1750)	1.4 (435)	1.2 (356)	18°	23°	17°
16.00 R25	13.1 (3995)	12.7 (3865)	9.8 (3000)	8.2 (2486)	5.9 (1800)	1.6 (485)	1.3 (386)	20°	25°	19°
20.5 R25	13.1 (3995)	12.7 (3865)	9.8 (3000)	8.2 (2507)	5.9 (1800)	1.6 (485)	1.3 (386)	20°	25°	19°

Ra = Radius all wheels steered

*Lowered

GMK5115

counterweight

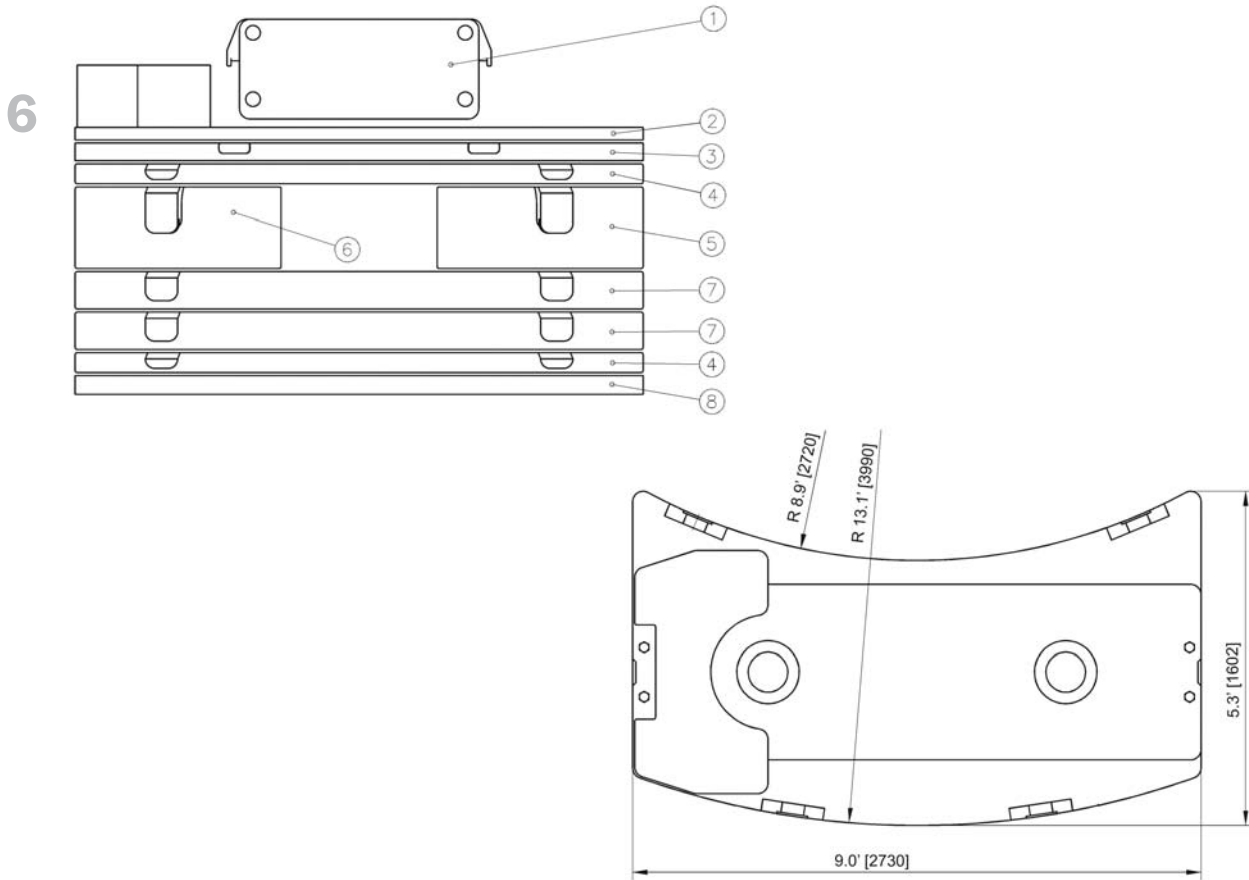

- | | |
|--|-----------------------------------|
| 1. 1,323 lb.(600 kg.) Bolted (Aux. Hoist or IPO) | 5. 7,275 lb.(3 300 kg.) Stacking |
| 2. 5,071 lb.(2 300 kg.) Bolted | 6. 7,275 lb.(3 300 kg.) Stacking |
| 3. 4 850 lb.(2 200 kg.) Stacking | 7. 9,700 lb (4 400 kg.) Stacking |
| 4. 4,850 lb.(2 200 kg.) Stacking | 8. 4,850 lb (2 200 kg.) Baseplate |

	1	2	3	4	5	6	7	8
Counterweight Configuration lb.(kg.)								
6,400 (2 900)	●	●						
11,250 (5 100)	●	●						●
16,100 (7 300)	●	●	●					●
20,950 (9 500)	●	●					●	●
25,600 (11 700)	●	●	●				●	●
30,650 (13 900)	●	●	●		●	●		●
35,500 (16 100)	●	●	●	●	●	●		●
40,350 (18 300)	●	●	●	2●	●	●		●
45,200 (20 500)	●	●	●	●	●	●	●	●
50,050 (22 700)	●	●	●		●	●	2●	●
54,900 (24 900)	●	●	●	●	●	●	2●	●
59,750 (27 100)	●	●	●	2●	●	●	2●	●

GMK5115

weight proposal

7

Trailing Boom

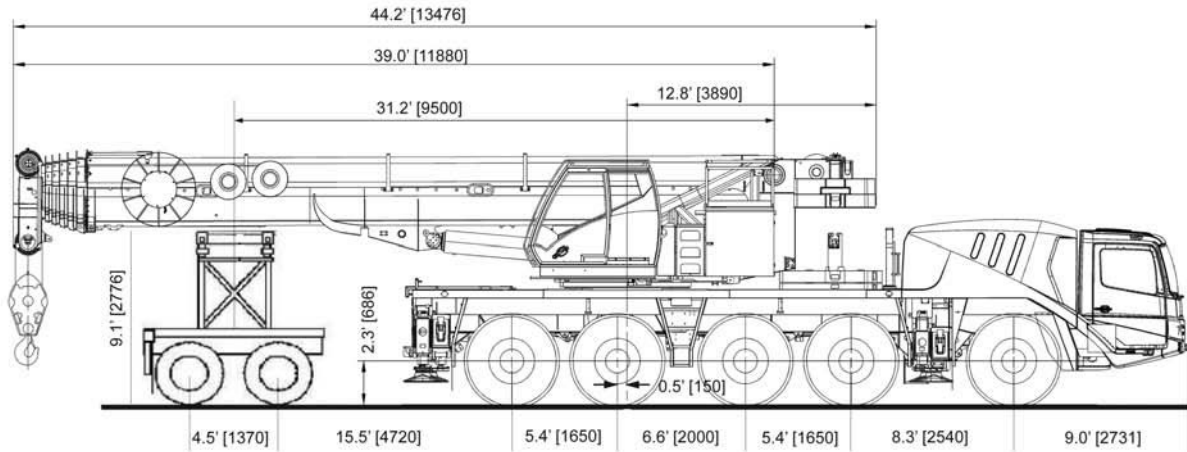

Dolly
26,676 lb.
(12 000 kg)

Rear 3 Axles
50,981 lb.
(23 125 kg)

Front 2 Axles
38,460 lb.
(17 446 kg)

Unit Configuration:

42' – 197' boom
Outrigger pads stowed on unit
10 X 8 X 10 drive/steer
Main and auxiliary hoists with cable

36 – 59 ft. hydraulic luffing swingaway
Additional oil cooler
20.5 tires
2 axle boom dolly (5,710 lb. / 2 590 kg)
Fixed cover weight (5,070 lb. / 2 300kg)

Boom Over Front

Basic Weights - lbs (kg)	Axles 1 & 2		Axles 3 - 5		Total	
Mercedes power, 16.00R25 tires, 10x6x10 drive/steer, 2nd oil cooler, outrigger pads, auxiliary hoist, driver and tanks filled	36,381	(16,502)	68,835	(31,223)	105,216	(47,725)
Additions:						
10x8x10 drive/steer						
Electric driveline retarder	-187	(-85)	760	(345)	573	(260)
Spare wheel 14.00 R25 XGC steel rim with stowage	-474	(-215)	1,045	(474)	571	(259)
Spare wheel 16.00 R25 XGC steel rim with stowage	-592	(-268)	1,295	(587)	703	(319)
Spare wheel 20.5 R25 XGC steel rim with stowage	-680	(-309)	1,478	(671)	798	(362)
Brackets for hydraulic swingaway	143	(65)	36	(16)	179	(81)
Hose reel + parts for hydraulic swingaway	604	(274)	-185	(-84)	419	(190)
33 ft. - 56 ft. (10-17m) hydraulic swingaway	2,761	(1,253)	105	(47)	2,866	(1,300)
Auxiliary boom nose	293	(133)	-139	(-63)	154	(70)
4,850 lb. (2200 kg) section 3 pinned to superstructure	-3,514	(-1,594)	8,364	(3,794)	4,850	(2,200)
4,850 lb. (2200 kg) section 8 stowed on carrier	3,271	(1,484)	1,579	(716)	4,850	(2,200)
Substitutions:						
14.00R25 tires	-504	(-228)	-819	(-372)	-1,323	(-600)
20.5R25 tires	361	(164)	587	(266)	948	(430)
Removals:						
Boom assembly	-20,890	(-9,476)	-8,817	(-3,999)	-29,707	(-13,475)
Front outriggers	-3,095	(-1,404)	-13	(-6)	-3,109	(-1,410)
Rear outriggers	2,250	(1,021)	-5,557	(-2,521)	-3,307	(-1,500)
Front and rear outrigger floats	-69	(-32)	-371	(-168)	-441	(-200)

GMK5115

working range

38.2 -196.9 ft (11.7 - 60 m) main boom

8

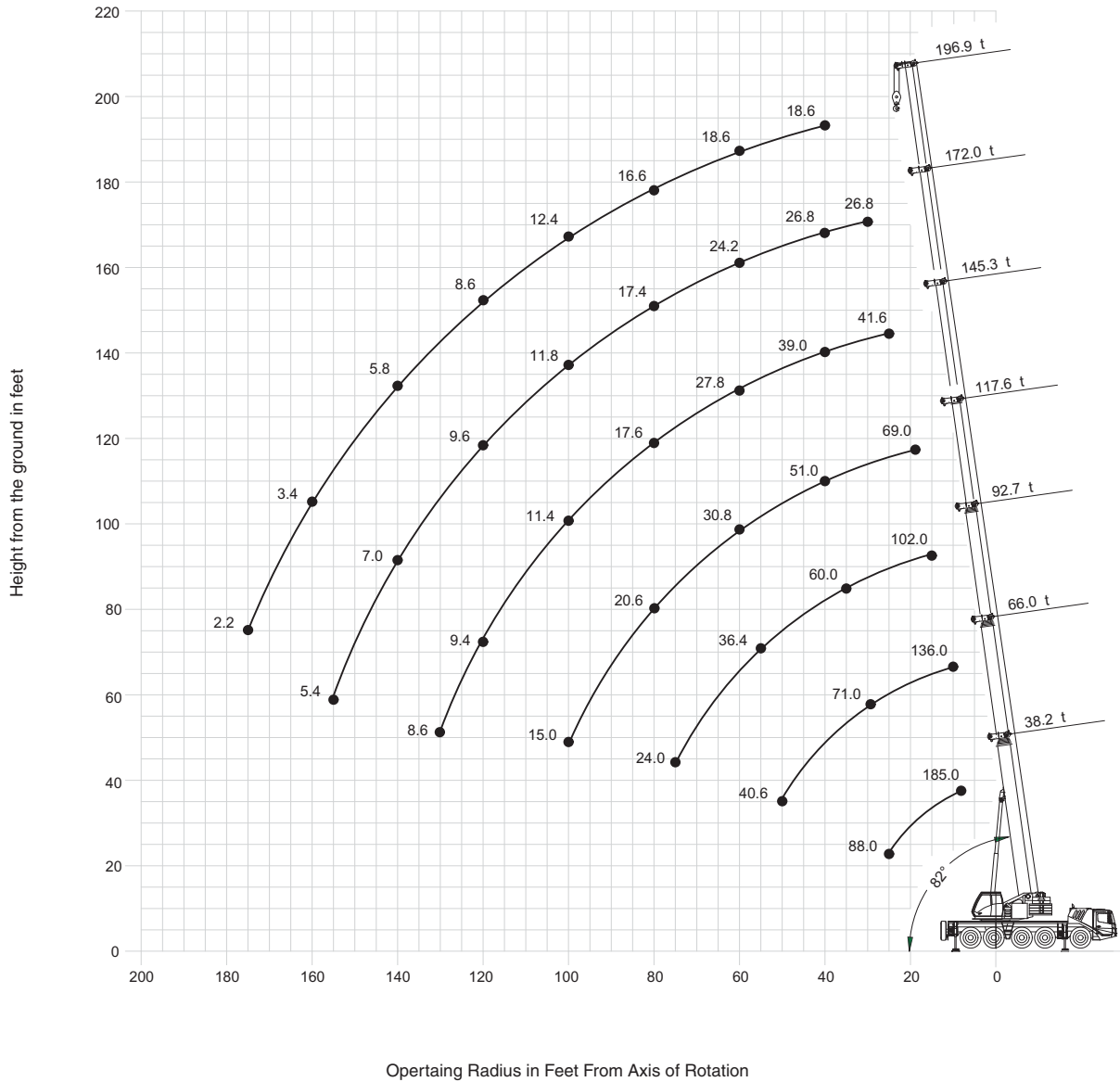

GMK5115

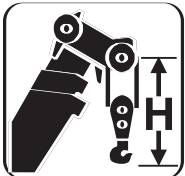
	Hook block (t)	H (ft)
	100 D	10.1
	70 S/D	9.8
	40 S/D	9.5
	20 S/D	9.2
	8 H/B	7.7

Hook heights shown in the working range diagram do not consider loaded boom deflection.

THIS CHART IS ONLY A GUIDE AND SHOULD NOT BE USED TO OPERATE THE CRANE. The individual crane's load chart, operating instructions and other instructional plates must be read and understood prior to operating the crane.

load charts

9

38.2-196.9 ft.
 (11.7-60 m)



25.6 x 24.6 ft.
 100%



59,700 lb.
 (27,100 kg)



360°

Feet	Pounds (thousands)												
	38.2	52.2	66.0	79.6	92.7	105.4	117.6	131.5	145.3	158.9	172.0	184.7	196.9
8.0	230.0*												
9.0	173.0												
10.0	158.0	146.0	136.0	130.0									
15.0	127.0	121.0	114.0	108.0	102.0								
20.0	106.0	101.0	95.0	93.0	87.0	84.0	69.0	53.0					
25.0	88.0	87.0	81.0	79.0	77.0	74.0	69.0	53.0	41.6				
30.0		75.0	71.0	69.0	68.0	65.0	64.0	52.0	41.6	33.2	26.8		
35.0		63.0	63.0	61.0	60.0	58.0	57.0	48.0	41.2	33.2	26.8	22.0	
40.0		54.0	54.0	54.0	54.0	51.0	51.0	43.6	39.0	33.0	26.8	22.0	18.6
45.0			47.0	46.0	47.0	45.0	46.0	39.4	36.0	32.6	26.8	22.0	18.6
50.0			40.6	40.2	41.2	40.0	39.6	36.4	33.2	30.4	26.8	22.0	18.6
55.0				36.4	36.4	36.8	34.8	32.6	30.6	28.0	25.6	22.0	18.6
60.0				32.8	32.2	33.2	30.8	28.8	27.8	25.6	24.2	21.8	18.6
65.0				29.0	28.2	29.6	27.4	26.4	24.6	23.8	22.6	21.0	18.6
70.0					25.6	26.4	24.6	25.0	22.0	21.8	21.0	19.8	18.2
75.0					24.0	23.6	22.2	22.8	19.6	19.4	19.4	18.8	17.4
80.0						21.0	20.6	20.8	17.6	17.4	17.4	17.6	16.6
85.0						19.0	19.8	18.8	15.8	15.6	15.8	16.2	15.8
90.0						17.0	18.2	17.0	14.2	14.6	14.2	14.6	15.0
95.0							16.4	15.2	12.8	13.4	12.8	13.2	13.6
100.0							15.0	13.8	11.4	12.4	11.8	12.0	12.4
105.0								12.6	10.8	11.8	11.2	11.2	11.4
110.0								11.4	10.2	11.2	10.6	10.6	10.4
115.0								10.2	9.8	10.8	10.2	10.0	9.4
120.0									9.4	10.2	9.6	9.6	8.6
125.0									9.0	9.2	9.2	8.8	7.8
130.0									8.6	8.4	8.4	8.0	7.2
135.0										7.8	7.6	7.2	6.4
140.0										7.2	7.0	6.6	5.8
145.0											6.6	6.0	5.2
150.0											6.0	5.4	4.6
155.0											5.4	4.8	4.0
160.0												4.4	3.4
165.0													3.8
170.0													3.4
175.0													2.2

* over rear with special equipment

38.2-196.9 ft.
 (11.7-60 m)

25.6 x 24.6 ft.
 100%

50,000 lb.
 (22,700 kg)

360°





Feet	Pounds (thousands)												
	38.2	52.2	66.0	79.6	92.7	105.4	117.6	131.5	145.3	158.9	172.0	184.7	196.9
8.0	185.0												
9.0	173.0												
10.0	158.0	146.0	136.0	130.0									
15.0	127.0	121.0	114.0	108.0	102.0								
20.0	106.0	101.0	95.0	93.0	87.0	84.0	69.0	53.0					
25.0	88.0	87.0	81.0	79.0	77.0	74.0	69.0	53.0	41.6				
30.0		73.0	71.0	69.0	68.0	65.0	64.0	52.0	41.6	33.2	26.8		
35.0		61.0	61.0	61.0	60.0	57.0	57.0	48.0	41.2	33.2	26.8	22.0	
40.0		51.0	52.0	51.0	51.0	48.0	48.0	43.6	39.0	33.0	26.8	22.0	18.6
45.0			44.0	43.6	43.6	43.8	41.2	38.6	36.0	32.6	26.8	22.0	18.6
50.0			38.0	39.6	37.8	38.2	35.6	33.4	32.2	30.4	26.6	22.0	18.6
55.0				34.0	33.0	33.6	31.2	30.2	28.0	27.6	25.6	22.0	18.6
60.0				29.6	30.0	29.8	27.6	28.2	24.6	24.2	24.2	21.8	18.6
65.0				26.0	27.4	26.6	24.4	24.0	21.8	21.4	21.4	21.0	18.6
70.0					24.2	23.6	23.0	22.6	19.2	19.0	19.0	19.4	18.2
75.0					21.6	21.0	21.8	20.2	17.0	17.2	17.0	17.4	17.4
80.0						18.6	19.8	18.4	15.2	16.2	15.8	16.2	16.0
85.0						17.8	17.8	16.6	13.8	15.4	14.6	15.0	14.4
90.0						16.8	16.0	14.8	12.8	14.6	13.4	13.6	13.0
95.0							14.4	13.2	12.0	13.4	12.6	12.8	11.8
100.0							13.2	12.0	11.4	12.4	11.8	11.8	10.6
105.0								10.8	10.8	11.6	11.2	10.8	9.6
110.0								9.6	10.2	10.6	10.4	9.8	8.6
115.0								8.6	9.8	9.6	9.6	8.8	7.8
120.0									9.4	8.8	8.6	8.0	7.0
125.0									8.8	8.2	8.0	7.4	6.2
130.0									8.0	7.8	7.2	6.6	5.6
135.0										7.2	6.6	5.8	5.0
140.0											6.0	5.2	4.4
145.0										6.6		5.4	4.6
150.0											4.8	4.0	3.2
155.0											4.2	3.6	2.8
160.0												3.0	2.2
165.0													2.6
170.0													2.2

THIS CHART IS ONLY A GUIDE AND SHOULD NOT BE USED TO OPERATE THE CRANE. The individual crane's load chart, operating instructions and other instructional plates must be read and understood prior to operating the crane.

GMK5115

load charts

10

 38.2-196.9 ft.
(11.7-60 m)
  25.6 x 24.6 ft.
(100%)
  6,300 lb.
(2,900 kg)
  360°

Feet	38.2	52.2	66.0	79.6	92.7	105.4	117.6	131.5	145.3	158.9	172.0	184.7	196.9
8.0	185.0												
9.0	173.0												
10.0	158.0	146.0	136.0	130.0									
15.0	127.0	121.0	114.0	108.0	102.0								
20.0	94.0	91.0	84.0	81.0	74.0	72.0	65.0	53.0					
25.0	67.0	65.0	63.0	59.0	58.0	54.0	49.0	46.0	41.6				
30.0		48.0	47.0	47.0	44.0	40.8	40.8	37.0	31.8	30.6	26.8		
35.0		38.2	38.4	37.2	35.0	35.2	32.6	29.6	29.4	28.2	24.2	22.0	
40.0		28.6	30.8	30.0	29.6	28.8	26.6	25.4	25.8	24.6	23.0	20.8	18.6
45.0			25.2	24.8	25.6	24.2	22.2	23.4	22.0	20.8	19.4	17.8	16.2
50.0			20.4	21.6	21.6	20.4	19.8	20.0	18.8	17.6	16.4	15.0	13.4
55.0				18.8	18.6	18.6	18.0	17.2	16.2	15.0	14.0	12.6	11.2
60.0				15.8	16.0	16.2	15.6	15.0	14.0	13.0	11.8	10.6	9.4
65.0				13.2	13.6	14.2	13.6	13.0	12.0	11.2	10.2	9.0	7.8
70.0					11.8	12.4	11.8	11.4	10.4	9.6	8.6	7.6	6.2
75.0					10.2	10.6	10.4	10.0	9.2	8.2	7.4	6.2	5.0
80.0						9.2	9.2	8.8	8.0	7.2	6.2	5.2	4.0
85.0						8.0	8.0	7.6	6.8	6.0	5.2	4.2	3.0
90.0						7.0	6.8	6.6	5.8	5.2	4.2	3.2	2.2
95.0							5.8	5.8	5.0	4.4	3.4	2.6	
100.0							3.4	4.8	4.2	3.6	2.8		
105.0								4.2	3.6	3.0	2.2		
110.0								3.4	3.0	2.4			
115.0									2.4				

GMK5115

THIS CHART IS ONLY A GUIDE AND SHOULD NOT BE USED TO OPERATE THE CRANE. The individual crane's load chart, operating instructions and other instructional plates must be read and understood prior to operating the crane.

GROVE

working range

offsettable swingaway

197 ft (60 m) – main boom with 32.8-55.8 ft swingaway and 1x 16 ft insert

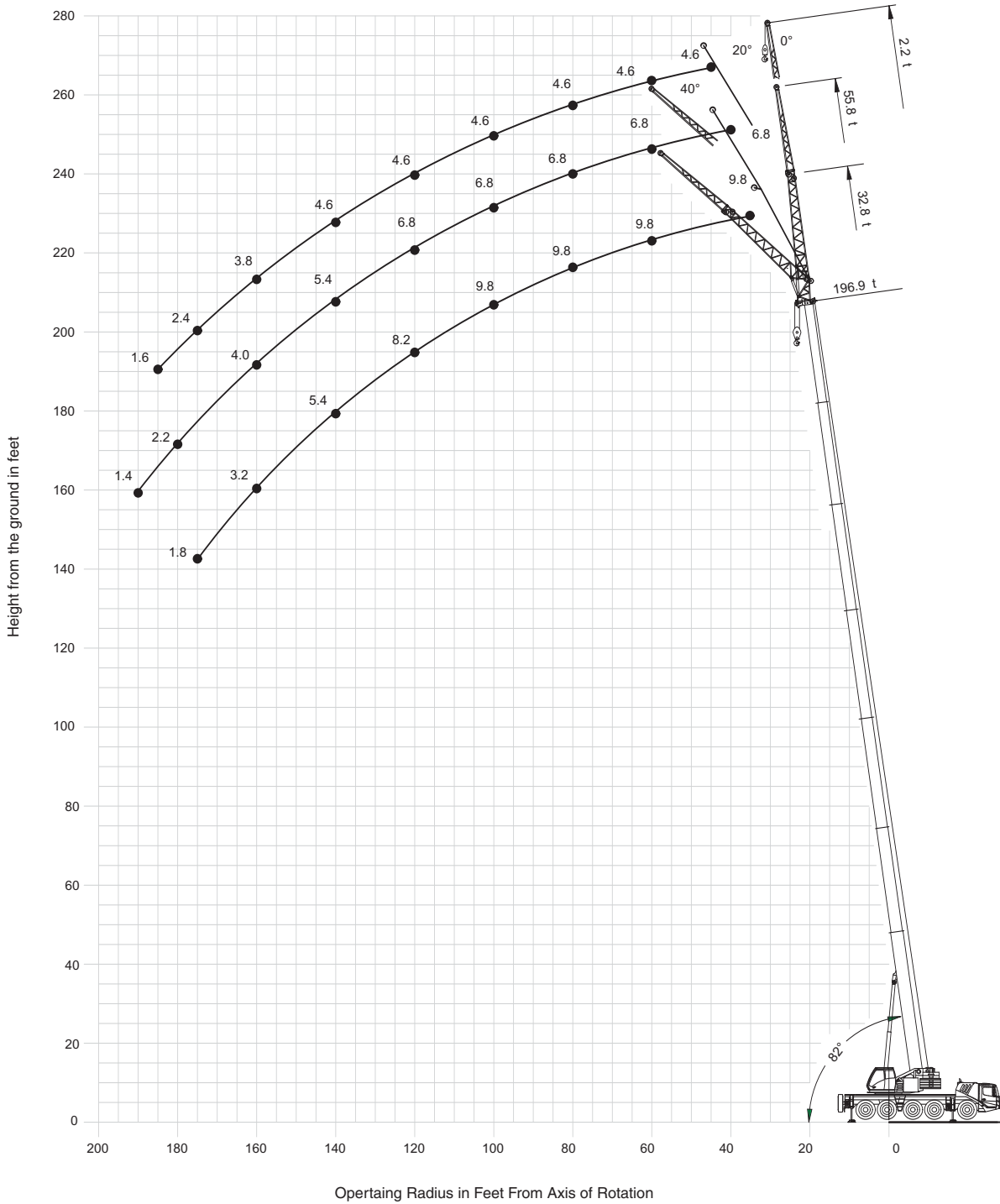

11

Hook heights shown in the working range diagram do not consider loaded boom deflection.

THIS CHART IS ONLY A GUIDE AND SHOULD NOT BE USED TO OPERATE THE CRANE. The individual crane's load chart, operating instructions and other instructional plates must be read and understood prior to operating the crane.

GMK5115

GROVE

load charts

hydraulic offsettable swingaway

12



Intermediate Angle

Feet	Pounds (thousands)								
	197 FT + 33 FT			197 FT + 56 FT			197 FT + 72 FT		
	0°	0°-20°	20°-40°	0°	0°-20°	20°-40°	0°	0°-20°	20°-40°
30.0									
35.0	9.8								
40.0	9.8			6.8					
45.0	9.8			6.8			4.6		
50.0	9.8			6.8			4.6		
55.0	9.8	9.2		6.8			4.6		
60.0	9.8	9.2	8.8	6.8			4.6		
65.0	9.8	9.2	8.8	6.8			4.6		
70.0	9.8	9.2	8.8	6.8	6.2		4.6		
75.0	9.8	9.2	8.8	6.8	6.2		4.6	4.6	
80.0	9.8	9.2	8.8	6.8	6.2	5.4	4.6	4.6	4.6
85.0	9.8	9.2	8.8	6.8	6.2	5.4	4.6	4.6	4.6
90.0	9.8	9.2	8.8	6.8	6.2	5.4	4.6	4.6	4.6
95.0	9.8	9.2	8.8	6.8	6.2	5.4	4.6	4.6	4.6
100.0	9.8	9.2	8.8	6.8	6.2	5.4	4.6	4.6	4.6
105.0	9.6	9.2	8.8	6.8	6.2	5.4	4.6	4.6	4.6
110.0	9.2	9.0	8.8	6.8	6.2	5.4	4.6	4.6	4.6
115.0	8.4	8.4	8.8	6.8	6.2	5.4	4.6	4.6	4.6
120.0	7.6	7.6	8.2	6.8	6.2	5.4	4.6	4.6	4.6
125.0	6.8	6.8	7.4	6.8	6.2	5.4	4.6	4.6	4.6
130.0	6.2	6.2	6.6	6.4	6.2	5.4	4.6	4.6	4.6
135.0	5.4	5.4	6.0	5.8	5.8	5.4	4.6	4.6	4.6
140.0	4.8	4.8	5.4	5.2	5.2	5.4	4.6	4.6	4.6
145.0	4.4	4.4	4.8	4.6	4.6	5.4	4.4	4.4	4.6
150.0	3.8	3.8	4.2	4.2	4.2	5.0	3.8	3.8	4.6
155.0	3.4	3.4	3.8	3.6	3.6	4.4	3.4	3.4	4.2
160.0	2.8	2.8	3.2	3.2	3.2	4.0	3.0	3.0	3.8
165.0	2.4	2.4	2.8	2.8	2.8	3.4	2.4	2.4	3.2
170.0	2.0	2.0	2.4	2.4	2.4	3.0	2.0	2.0	2.8
175.0	1.6	1.6	1.8	2.0	2.0	2.6	1.8	1.8	2.4
180.0				1.6	1.6	2.2			2.0
185.0						1.8			1.6
190.0						1.4			



Loads for Luffing

Feet	Pounds (thousands)					
	197 FT + 33 FT		197 FT + 56 FT		197 FT + 72 FT	
	0°-20°	20°-40°	0°-20°	20°-40°	0°-20°	20°-40°
50.0						
55.0	8.8					
60.0	8.8	8.4				
65.0	8.8	8.4				
70.0	8.8	8.4	6.0			
75.0	8.8	8.4	6.0		4.4	
80.0	8.8	8.4	6.0	5.2	4.4	
85.0	8.8	8.4	6.0	5.2	4.4	4.4
90.0	8.8	8.4	6.0	5.2	4.4	4.4
95.0	8.8	8.4	6.0	5.2	4.4	4.4
100.0	8.8	8.4	6.0	5.2	4.4	4.4
105.0	8.8	8.4	6.0	5.2	4.4	4.4
110.0	8.6	8.4	6.0	5.2	4.4	4.4
115.0	8.4	8.4	6.0	5.2	4.4	4.4
120.0	7.6	8.0	6.0	5.2	4.4	4.4
125.0	6.8	7.4	5.8	5.2	4.4	4.4
130.0	6.0	6.6	5.6	5.2	4.4	4.4
135.0	5.4	6.0	5.6	5.2	4.4	4.4
140.0	4.8	5.2	5.2	5.0	4.4	4.4
145.0	4.2	4.6	4.6	5.0	4.4	4.4
150.0	3.6	4.0	4.2	5.0	3.8	4.4
155.0	3.2	3.6	3.6	4.4	3.4	4.2
160.0	2.6	3.0	3.2	3.8	3.0	3.8
165.0	2.2	2.6	2.8	3.4	2.4	3.2
170.0	1.8	2.2	2.4	3.0	2.0	2.8
175.0		1.8	2.0	2.4	1.8	2.4
180.0			1.6	2.0		2.0
185.0				1.8		1.6

GMK5115

THIS CHART IS ONLY A GUIDE AND SHOULD NOT BE USED TO OPERATE THE CRANE. The individual crane's load chart, operating instructions and other instructional plates must be read and understood prior to operating the crane.

load charts

hydraulic offsettable swingaway

Intermediate Angle

197 ft. (60 m) 33-56-72 ft. (10-17-22 m) 50,000 lbs. (22,700 kg) 25.6 x 24.6 ft. 100% 360°

Feet	Pounds (thousands)								
	197' + 33'			197' + 56'			197' + 72'		
	0°	0°- 20°	20°- 40°	0°	0°- 20°	20°- 40°	0°	0°- 20°	20°- 40°
30.0									
35.0	9.8								
40.0	9.8			6.8					
45.0	9.8			6.8			4.6		
50.0	9.8			6.8			4.6		
55.0	9.8	9.2		6.8			4.6		
60.0	9.8	9.2	8.8	6.8			4.6		
65.0	9.8	9.2	8.8	6.8			4.6		
70.0	9.8	9.2	8.8	6.8	6.2		4.6		
75.0	9.8	9.2	8.8	6.8	6.2		4.6	4.6	
80.0	9.8	9.2	8.8	6.8	6.2	5.4	4.6	4.6	4.6
85.0	9.8	9.2	8.8	6.8	6.2	5.4	4.6	4.6	4.6
90.0	9.8	9.2	8.8	6.8	6.2	5.4	4.6	4.6	4.6
95.0	9.8	9.2	8.8	6.8	6.2	5.4	4.6	4.6	4.6
100.0	9.4	9.2	8.8	6.8	6.2	5.4	4.6	4.6	4.6
105.0	8.6	8.6	8.8	6.8	6.2	5.4	4.6	4.6	4.6
110.0	7.6	7.6	8.4	6.8	6.2	5.4	4.6	4.6	4.6
115.0	6.8	6.8	7.4	6.8	6.2	5.4	4.6	4.6	4.6
120.0	6.0	6.0	6.6	6.4	6.2	5.4	4.6	4.6	4.6
125.0	5.2	5.2	6.0	5.6	5.6	5.4	4.6	4.6	4.6
130.0	4.6	4.6	5.2	5.0	5.0	5.4	4.6	4.6	4.6
135.0	4.0	4.0	4.6	4.4	4.4	5.4	4.2	4.2	4.6
140.0	3.4	3.4	4.0	3.8	3.8	4.8	3.6	3.6	4.6
145.0	3.0	3.0	3.4	3.4	3.4	4.2	3.0	3.0	4.0
150.0	2.4	2.4	2.8	2.8	2.8	3.6	2.6	2.6	3.4
155.0	2.0	2.0	2.4	2.4	2.4	3.2	2.2	2.2	3.0
160.0	1.6	1.6	2.0	2.0	2.0	2.8	1.6	1.6	2.4
165.0			1.6	1.6	1.6	2.2			2.0
170.0						1.8			1.6

13

Loads for Luffing

197 ft. (60 m) 33-56-72 ft. (10-17-22 m) 50,000 lbs. (22,700 kg) 25.6 x 24.6 ft. 100% 360°

Feet	Pounds (thousands)					
	197' + 33'		197' + 56'		197' + 72'	
	0°- 20°	20°- 40°	0°- 20°	20°- 40°	0°- 20°	20°- 40°
50.0						
55.0	8.8					
60.0	8.8	8.4				
65.0	8.8	8.4				
70.0	8.8	8.4				
75.0	8.8	8.4	6.0		4.4	
80.0	8.8	8.4	6.0	5.2	4.4	
85.0	8.8	8.4	6.0	5.2	4.4	4.4
90.0	8.8	8.4	6.0	5.2	4.4	4.4
95.0	8.8	8.4	6.0	5.2	4.4	4.4
100.0	8.8	8.4	6.0	5.2	4.4	4.4
105.0	8.6	8.4	6.0	5.2	4.4	4.4
110.0	7.6	8.4	6.0	5.2	4.4	4.4
115.0	6.8	7.4	6.0	5.2	4.4	4.4
120.0	6.0	6.6	6.0	5.2	4.4	4.4
125.0	5.2	6.0	5.6	5.2	4.4	4.4
130.0	4.6	5.2	5.0	5.2	4.4	4.4
135.0	4.0	4.6	4.4	5.2	4.2	4.4
140.0	3.4	4.0	3.8	4.8	3.6	4.4
145.0	3.0	3.4	3.4	4.2	3.0	4.0
150.0	2.4	2.8	2.8	3.6	2.6	3.4
155.0	2.0	2.4	2.4	3.2	2.2	3.0
160.0	1.6	2.0	2.0	2.8	1.6	2.4
165.0		1.4	1.6	2.2		2.0
170.0				1.8		1.6

THIS CHART IS ONLY A GUIDE AND SHOULD NOT BE USED TO OPERATE THE CRANE. The individual crane's load chart, operating instructions and other instructional plates must be read and understood prior to operating the crane.

GMK5115

load charts

manual offset swingaway

14



197 ft.
(60 m)



33-56-72 ft.
(10-17-22 m)



59,700 lbs.
(27,100 kg)



25.6 x 24.6 ft.
(100%)



360°

Feet	Pounds (thousands)								
	197' + 33'			197' + 56'			197' + 72'		
	0°	20°	40°	0°	20°	40°	0°	20°	40°
30.0									
35.0	9.8								
40.0	9.8			6.8					
45.0	9.8			6.8			4.6		
50.0	9.8	9.8		6.8			4.6		
55.0	9.8	9.8	8.8	6.8			4.6		
60.0	9.8	9.8	8.8	6.8	6.8		4.6	4.6	
65.0	9.8	9.8	8.8	6.8	6.8		4.6	4.6	
70.0	9.8	9.8	8.8	6.8	6.8		4.6	4.6	
75.0	9.8	9.8	8.8	6.8	6.8	5.4	4.6	4.6	4.6
80.0	9.8	9.8	8.8	6.8	6.8	5.4	4.6	4.6	4.6
85.0	9.8	9.8	8.8	6.8	6.8	5.4	4.6	4.6	4.6
90.0	9.8	9.8	8.8	6.8	6.8	5.4	4.6	4.6	4.6
95.0	9.8	9.8	8.8	6.8	6.8	5.4	4.6	4.6	4.6
100.0	9.8	9.6	8.8	6.8	6.8	5.4	4.6	4.6	4.6
105.0	9.6	9.4	8.8	6.8	6.8	5.4	4.6	4.6	4.6
110.0	9.2	9.0	8.8	6.8	6.8	5.4	4.6	4.6	4.6
115.0	8.4	8.8	8.8	6.8	6.8	5.4	4.6	4.6	4.6
120.0	7.6	8.2	8.6	6.8	6.6	5.4	4.6	4.6	4.6
125.0	6.8	7.4	7.8	6.8	6.6	5.4	4.6	4.6	4.6
130.0	6.2	6.6	7.0	6.4	6.4	5.4	4.6	4.6	4.6
135.0	5.4	6.0	6.4	5.8	6.2	5.4	4.6	4.6	4.6
140.0	4.8	5.4	5.6	5.2	6.2	5.4	4.6	4.6	4.6
145.0	4.4	4.8	5.0	4.6	5.6	5.4	4.4	4.6	4.6
150.0	3.8	4.2	4.4	4.2	5.0	5.4	3.8	4.6	4.6
155.0	3.4	3.8	4.0	3.6	4.4	5.0	3.4	4.2	4.4
160.0	2.8	3.2	3.4	3.2	4.0	4.4	3.0	3.8	4.2
165.0	2.4	2.8	3.0	2.8	3.4	4.0	2.4	3.2	3.8
170.0	2.0	2.4	2.4	2.4	3.0	3.4	2.0	2.8	3.2
175.0	1.6	1.8	2.0	2.0	2.6	3.0	1.8	2.4	2.8
180.0				1.6	2.2	2.6		2.0	2.4
185.0					1.8	2.0		1.6	2.0
190.0					1.4	1.6			1.6



197 ft.
(60 m)



33-56-72 ft.
(10-17-22 m)



50,000 lbs.
(22,700 kg)



25.6 x 24.6 ft.
(100%)



360°

Feet	Pounds (thousands)								
	197' + 33'			197' + 56'			197' + 72'		
	0°	20°	40°	0°	20°	40°	0°	20°	40°
30.0									
35.0	9.8								
40.0	9.8			6.8					
45.0	9.8			6.8			4.6		
50.0	9.8	9.8		6.8			4.6		
55.0	9.8	9.8	8.8	6.8			4.6		
60.0	9.8	9.8	8.8	6.8	6.8		4.6	4.6	
65.0	9.8	9.8	8.8	6.8	6.8		4.6	4.6	
70.0	9.8	9.8	8.8	6.8	6.8		4.6	4.6	
75.0	9.8	9.8	8.8	6.8	6.8	5.4	4.6	4.6	4.6
80.0	9.8	9.8	8.8	6.8	6.8	5.4	4.6	4.6	4.6
85.0	9.8	9.8	8.8	6.8	6.8	5.4	4.6	4.6	4.6
90.0	9.8	9.8	8.8	6.8	6.8	5.4	4.6	4.6	4.6
95.0	9.8	9.8	8.8	6.8	6.8	5.4	4.6	4.6	4.6
100.0	9.4	9.6	8.8	6.8	6.8	5.4	4.6	4.6	4.6
105.0	8.6	9.2	8.8	6.8	6.8	5.4	4.6	4.6	4.6
110.0	7.6	8.4	8.8	6.8	6.8	5.4	4.6	4.6	4.6
115.0	6.8	7.4	8.0	6.8	6.8	5.4	4.6	4.6	4.6
120.0	6.0	6.6	7.2	6.4	6.6	5.4	4.6	4.6	4.6
125.0	5.2	6.0	6.4	5.6	6.6	5.4	4.6	4.6	4.6
130.0	4.6	5.2	5.6	5.0	6.0	5.4	4.6	4.6	4.6
135.0	4.0	4.6	5.0	4.4	5.4	5.4	4.2	4.6	4.6
140.0	3.4	4.0	4.2	3.8	4.8	5.4	3.6	4.6	4.6
145.0	3.0	3.4	3.6	3.4	4.2	4.8	3.0	4.0	4.6
150.0	2.4	2.8	3.2	2.8	3.6	4.2	2.6	3.4	4.2
155.0	2.0	2.4	2.6	2.4	3.2	3.8	2.2	3.0	3.6
160.0	1.6	2.0	2.2	2.0	2.8	3.2	1.6	2.4	3.0
165.0		1.6	1.6	1.6	2.2	2.8		2.0	2.6
170.0					1.8	2.2		1.6	2.0
175.0						1.8			1.6

GMK5115

THIS CHART IS ONLY A GUIDE AND SHOULD NOT BE USED TO OPERATE THE CRANE. The individual crane's load chart, operating instructions and other instructional plates must be read and understood prior to operating the crane.

38.2 - 196.9 ft (11.7 - 60 m) main boom with 10.8 ft heavy duty jib

15

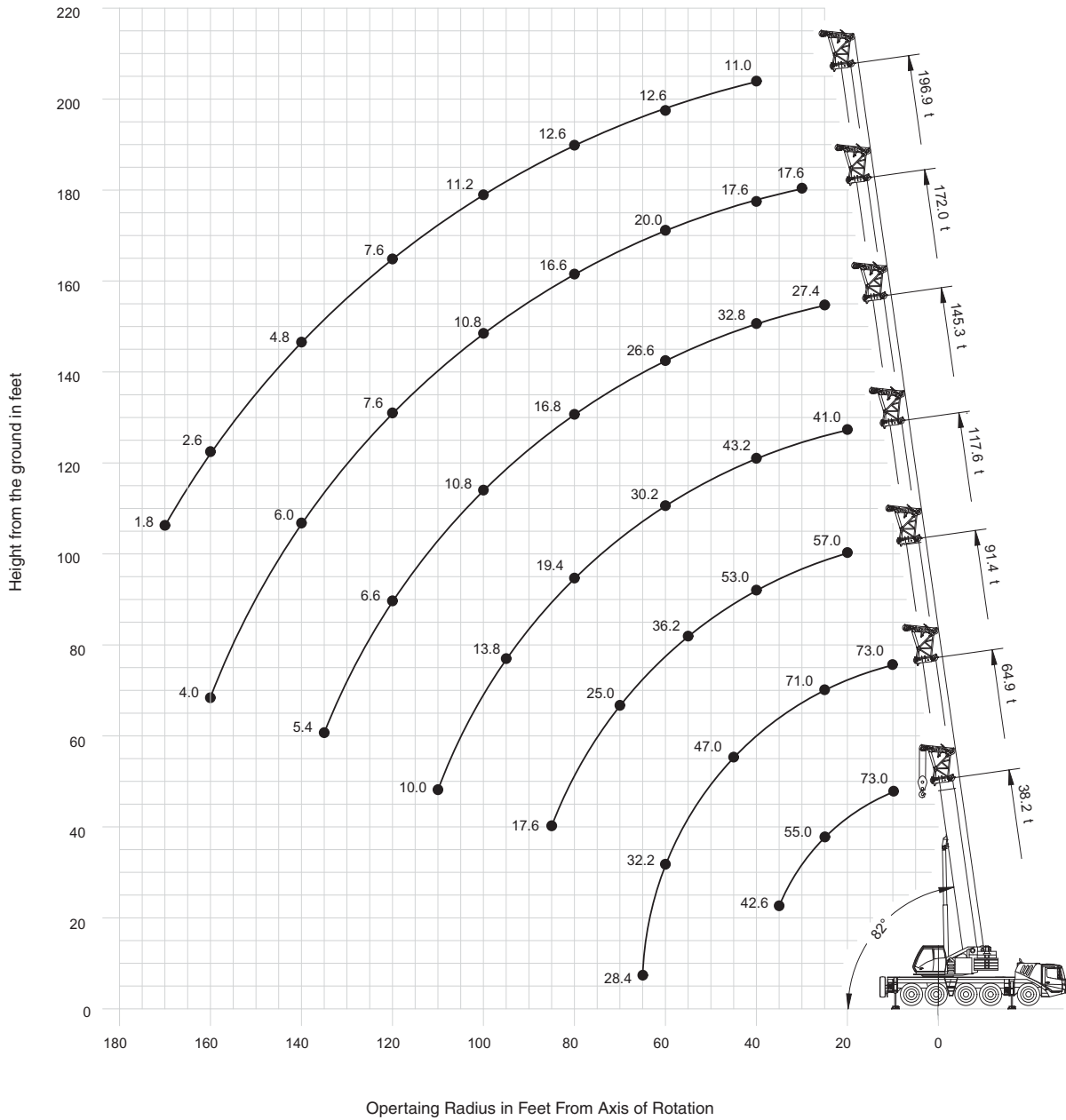

Hook heights shown in the working range diagram do not consider loaded boom deflection.





THIS CHART IS ONLY A GUIDE AND SHOULD NOT BE USED TO OPERATE THE CRANE. The individual crane's load chart, operating instructions and other instructional plates must be read and understood prior to operating the crane.

GMK5115

load charts





Integrated Heavy Duty Jib

16

 38-197 ft. (11.7-60.0 m)
  10.8 ft. (3.3 m)
  59,700 lbs. (27,100 kg)
  25.6 x 24.6 ft. 100%
  360°

Intermediate Angle

Feet	Pounds (thousands)																				
	38.2' + 10.8'			64.9' + 10.8'			91.4' + 10.8'			117.6' + 10.8'			145.3' + 10.8'			172.0' + 10.8'			196.9' + 10.8'		
	0°	< 20°	< 40°	0°	< 20°	< 40°	0°	< 20°	< 40°	0°	< 20°	< 40°	0°	< 20°	< 40°	0°	< 20°	< 40°	0°	< 20°	< 40°
10.0	73.0	73.0	73.0			73.0															
15.0	71.0	65.0	66.0			73.0															
20.0	60.0	57.0	59.0	73.0	71.0	70.0			57.0			41.0									
25.0	51.0	51.0	55.0	71.0	65.0	65.0	73.0	68.0	57.0			41.0			27.4						
30.0	45.0	46.0		63.0	59.0	61.0	64.0	64.0	57.0	49.0	46.0	41.0			27.4				17.6		
35.0	40.2	42.6		57.0	55.0	58.0	58.0	57.0	57.0	46.0	43.6	41.0			27.4				17.6		
40.0				52.0	51.0	54.0	52.0	52.0	53.0	43.2	41.2	41.0	32.8	29.6	27.4				17.6		11.0
45.0				47.0	47.0	47.0	47.0	47.0	47.0	40.4	38.8	39.4	32.8	29.6	27.4	20.0	18.0	17.6			11.0
50.0				41.2	41.2		41.0	41.0	41.4	37.8	36.6	37.4	30.6	29.6	27.4	20.0	18.0	17.6	12.6	11.0	11.0
55.0				36.2	36.2		36.0	36.0	36.2	33.8	33.8	34.0	28.2	28.4	27.4	20.0	18.0	17.6	12.6	11.0	11.0
60.0				32.2			31.8	31.8	32.0	29.8	30.0	30.2	25.6	25.6	26.6	20.0	18.0	17.6	12.6	11.0	11.0
65.0				28.4			28.4	28.4	28.6	26.6	26.6	26.8	23.6	23.6	23.8	20.0	18.0	17.6	12.6	11.0	11.0
70.0							25.0	25.0		23.8	23.8	24.0	21.0	21.0	21.2	19.4	18.0	17.6	12.6	11.0	11.0
75.0							22.2	22.2		21.4	21.4	21.6	18.8	18.8	19.0	18.2	18.0	17.6	12.6	11.0	11.0
80.0							19.8	19.8		19.2	19.4	19.4	16.8	16.8	16.8	16.6	16.6	16.6	12.6	11.0	11.0
85.0							17.6	17.6		17.4	17.4	17.4	15.0	15.0	15.0	14.8	14.8	15.0	12.6	11.0	11.0
90.0										15.4	15.6		13.4	13.4	13.6	13.2	13.2	13.4	12.6	11.0	11.0
95.0										13.8	13.8		12.0	12.0	12.0	12.0	12.0	12.0	11.8	11.0	11.0
100.0										12.4	12.4		10.8	10.8	10.8	10.6	10.6	10.8	11.2	11.0	11.0
105.0										11.0	11.2		9.6	9.6	9.6	9.6	9.6	9.6	10.2	10.4	10.4
110.0										10.0	10.0		8.4	8.4	8.4	8.6	8.8	8.8	9.2	9.4	9.4
115.0													7.4	7.4		8.2	8.2	8.2	8.2	8.4	8.6
120.0													6.6	6.6		7.6	7.6	7.6	7.4	7.6	7.6
125.0													6.2	6.2		7.2	7.2	7.2	6.6	6.8	6.8
130.0													5.8	5.8		6.6	6.6	6.6	6.0	6.2	6.2
135.0													5.4	4.0		6.2	6.2		5.4	5.4	5.6
140.0																6.0	5.8		4.8	4.8	4.8
145.0																5.6	5.4		4.2	4.2	4.4
150.0																5.2	5.0		3.6	3.8	3.8
155.0																4.6	4.6		3.0	3.2	
160.0																4.0			2.6	2.6	
165.0																			2.0	2.2	
170.0																			1.6	1.8	

 38-197 ft. (11.7-60.0 m)
  10.8 ft. (3.3 m)
  59,700 lbs. (27,100 kg)
  25.6 x 24.6 ft. 100%
  360°

Loads for Luffing





Feet	Pounds (thousands)													
	38.2' + 10.8'		64.9' + 10.8'		91.4' + 10.8'		117.6' + 10.8'		145.3' + 10.8'		172.0' + 10.8'		196.9' + 10.8'	
	0°- 20°	20°- 40°	0°- 20°	20°- 40°	0°- 20°	20°- 40°	0°- 20°	20°- 40°	0°- 20°	20°- 40°	0°- 20°	20°- 40°	0°- 20°	20°- 40°
10.0	46.0	46.0			48.0									
15.0	43.4	44.0			46.0									
20.0	40.6	43.0	45.0	45.0		46.0			39.0					
25.0	38.6	42.8	43.8	44.0	45.0	45.0			39.0			26.0		
30.0	37.2		41.8	43.2	45.0	45.0	43.8	39.0				26.0		17.2
35.0	36.6		40.2	42.8	43.8	44.0	41.6	39.0				26.0		17.2
40.0			38.8	42.6	42.4	43.4	39.2	39.0	29.6	26.0		17.2		11.0
45.0			37.8	42.8	41.0	43.0	36.8	37.6	29.6	26.0	18.0	17.2		11.0
50.0			37.0		39.4	39.4	34.8	35.6	29.0	26.0	18.0	17.2	10.8	11.0
55.0			34.0		34.2	34.4	33.0	34.0	27.0	26.0	18.0	17.2	10.8	11.0
60.0					29.6	29.8	29.6	29.6	24.4	25.2	18.0	17.2	10.8	11.0
65.0					26.0	26.0	25.8	25.8	22.6	23.0	18.0	17.2	10.8	11.0
70.0					22.8		22.6	22.8	21.0	21.2	18.0	17.2	10.8	11.0
75.0					20.2		20.0	20.0	18.6	18.8	17.2	17.2	10.8	11.0
80.0					18.0		17.8	17.8	16.4	16.6	16.2	16.4	10.8	11.0
85.0					16.0		15.8	15.8	14.4	14.6	14.8	15.0	10.8	11.0
90.0							14.2		12.8	12.8	13.2	13.4	10.8	11.0
95.0							12.6		11.2	11.4	11.8	11.8	10.8	11.0
100.0							11.4		10.0	10.0	10.4	10.6	10.8	10.8
105.0							10.2		8.8	8.8	9.2	9.2	10.4	10.4
110.0								9.0	7.8	7.8	8.4	8.4	9.2	9.4
115.0									6.8		7.8	7.8	8.2	8.4
120.0									6.4		7.2	7.2	7.4	7.4
125.0									6.0		6.8	6.8	6.6	6.6
130.0									5.6		6.4	6.4	5.8	5.8
135.0									3.8		6.0		5.2	5.2
140.0											5.6		4.6	4.6
145.0											5.2		4.0	4.0
150.0											4.6		3.4	3.4
155.0											4.2		2.8	
160.0													2.4	
165.0													2.0	
170.0													1.6	

THIS CHART IS ONLY A GUIDE AND SHOULD NOT BE USED TO OPERATE THE CRANE. The individual crane's load chart, operating instructions and other instructional plates must be read and understood prior to operating the crane.

GMK5115

load charts





Integrated Heavy Duty Jib

 38-197 ft. (11.7-60.0 m)
 10.8 ft. (3.3 m)
 50,000 lbs. (22,700 kg)
 25.6 x 24.6 ft. (100%)
 360°

Intermediate Angle

Feet	Pounds (thousands)																				
	38.2' + 10.8'			64.9' + 10.8'			91.4' + 10.8'			117.6' + 10.8'			145.3' + 10.8'			172.0' + 10.8'			196.9' + 10.8'		
	0°	< 20°	< 40°	0°	< 20°	< 40°	0°	< 20°	< 40°	0°	< 20°	< 40°	0°	< 20°	< 40°	0°	< 20°	< 40°	0°	< 20°	< 40°
10.0	73.0	73.0	73.0			73.0															
15.0	71.0	65.0	66.0			73.0															
20.0	60.0	57.0	59.0	73.0	71.0	70.0															
25.0	51.0	51.0	55.0	71.0	65.0	65.0	73.0	68.0	57.0												
30.0	45.0	46.0		63.0	59.0	61.0	64.0	64.0	57.0	49.0	46.0	41.0									
35.0	40.2	42.6		57.0	55.0	58.0	58.0	57.0	57.0	46.0	43.6	41.0									
40.0				52.0	51.0	52.0	50.0	50.0	50.0	43.2	41.2	41.0	32.8	29.6	27.4						
45.0				45.0	45.0	45.0	42.6	42.6	43.0	39.8	38.8	39.4	32.8	29.6	27.4	20.0	18.0	17.6			
50.0				39.0	39.0		37.0	37.0	37.2	34.4	34.6	34.8	30.6	29.6	27.4	20.0	18.0	17.6	12.6	11.0	11.0
55.0				33.4	33.4		32.2	32.2	32.6	30.2	30.2	30.6	27.0	27.0	27.2	20.0	18.0	17.6	12.6	11.0	11.0
60.0				29.0			28.4	28.4	28.6	26.6	26.6	26.8	23.6	23.6	23.8	20.0	18.0	17.6	12.6	11.0	11.0
65.0				25.2			25.2	25.2	25.4	23.6	23.6	23.8	20.8	20.8	21.0	20.0	18.0	17.6	12.6	11.0	11.0
70.0							22.2	22.2		21.0	21.0	21.2	18.4	18.4	18.6	18.0	18.0	17.6	12.6	11.0	11.0
75.0							19.6	19.6		18.8	18.8	19.0	16.2	16.2	16.4	16.0	16.0	16.2	12.6	11.0	11.0
80.0							17.4	17.4		16.8	16.8	17.0	14.4	14.4	14.6	14.2	14.2	14.4	12.6	11.0	11.0
85.0							15.4	15.4		15.0	15.2	15.2	12.8	12.8	12.8	12.6	12.6	12.8	12.6	11.0	11.0
90.0										13.4	13.4		11.4	11.4	11.4	11.4	11.4	11.8	11.8	11.0	11.0
95.0										11.8	11.8		10.0	10.0	10.0	10.6	10.8	10.8	10.6	10.8	10.8
100.0										10.4	10.6		8.8	8.8	8.8	10.0	10.0	10.2	9.4	9.6	9.8
105.0										9.2	9.4		8.0	8.0	8.2	9.2	9.4	9.4	8.4	8.6	8.6
110.0													7.6	7.6	7.6	8.6	8.8	8.8	7.4	7.6	7.8
115.0													7.0	7.0		8.2	8.2	8.2	6.6	6.8	6.8
120.0													6.6	6.6		7.6	7.6	7.6	5.8	6.0	6.0
125.0													6.2	6.2		7.2	7.2	7.2	5.2	5.2	5.4
130.0													5.8	5.8		6.4	6.4	6.4	4.4	4.6	4.6
135.0													5.4	2.6		5.6	5.6		3.8	4.0	4.0
140.0																5.0	5.0		3.2	3.4	3.4
145.0																4.4	4.4		2.8	2.8	2.8
150.0																3.8	3.8		2.2	2.4	2.4
155.0																3.4	3.4		1.8	2.0	
160.0																			2.8		

17

 38-197 ft. (11.7-60.0 m)
 10.8 ft. (3.3 m)
 50,000 lbs. (22,700 kg)
 25.6 x 24.6 ft. 100%
 360°

Loads for Luffing

Feet	Pounds (thousands)													
	38.2' + 10.8'		64.9' + 10.8'		91.4' + 10.8'		117.6' + 10.8'		145.3' + 10.8'		172.0' + 10.8'		196.9' + 10.8'	
	0°- 20°	20°- 40°	0°- 20°	20°- 40°	0°- 20°	20°- 40°	0°- 20°	20°- 40°	0°- 20°	20°- 40°	0°- 20°	20°- 40°	0°- 20°	20°- 40°
10.0	46.0	46.0			48.0									
15.0	43.4	44.0			46.0									
20.0	40.6	43.0			45.0	45.0			39.0					
25.0	38.6	42.8			43.8	44.0			39.0					
30.0	37.2				41.8	43.2	45.0	45.0	43.8	39.0				26.0
35.0	36.6				40.2	42.8	43.8	44.0	41.6	39.0				26.0
40.0					38.8	42.6	42.4	43.4	39.2	39.0	29.6	26.0		17.2
45.0					37.8	42.8	41.0	43.0	36.8	37.6	29.6	26.0	18.0	17.2
50.0					36.0		36.0	36.4	34.8	34.8	29.0	26.0	18.0	17.2
55.0					30.6		30.8	31.0	30.2	30.6	27.0	26.0	18.0	17.2
60.0							26.6	26.6	26.4	26.6	23.6	23.8	18.0	17.2
65.0							23.2	23.2	23.0	23.0	20.8	21.0	18.0	17.2
70.0							20.2		20.0	20.2	18.4	18.6	18.0	17.2
75.0							17.8		17.6	17.8	16.2	16.4	16.0	16.2
80.0							15.8		15.6	15.6	14.2	14.4	14.2	14.4
85.0							14.0		13.8	13.8	12.4	12.6	12.6	12.8
90.0									12.2		10.8	11.0	11.2	11.4
95.0									10.8		9.4	9.6	10.2	10.4
100.0									9.6		8.2	8.4	9.7	9.6
105.0									8.4		7.8	7.8	8.8	9.0
110.0									7.6		7.2	7.2	8.4	8.4
115.0											6.8	7.8	7.8	6.8
120.0											6.4	7.2	7.2	6.0
125.0											6.0	6.6	6.6	5.2
130.0											5.6	5.8	5.8	4.6
135.0											2.4		5.2	3.8
140.0													4.6	3.2
145.0													4.0	2.8
150.0													3.6	2.2
155.0													3.0	1.8

THIS CHART IS ONLY A GUIDE AND SHOULD NOT BE USED TO OPERATE THE CRANE. The individual crane's load chart, operating instructions and other instructional plates must be read and understood prior to operating the crane.

GMK5115

Regional Headquarters

Americas

Manitowoc, Wisconsin, USA

Tel: +1 920 684 6621

Fax: +1 920 683 6278

Shady Grove, Pennsylvania, USA

Tel: +1 717 597 8121

Fax: +1 717 597 4062

Regional Offices

Americas

Brazil

Alphaville

Tel: +55 11 3103 0200

Fax: +55 11 4688 2013

Mexico

Monterrey

Tel: +52 81 8124 0128

Fax: +52 81 8124 0129

Europe, Middle East, Africa

Algeria

Hydra

Tel: +21 3 21 48 1173

Fax: +21 3 21 48 1454

Czech Republic

Netvorice

Tel: +420 317 78 9313

Fax: +420 317 78 9314

France

Baudemont

Tel: +33 385 28 2589

Fax: +33 385 28 0430

Cergy

Tel: +33 130 31 3150

Fax: +33 130 38 6085

Decines

Tel: +33 472 81 5000

Fax: +33 472 81 5010

Germany

Langenfeld

Tel: +49 21 73 8909-0

Fax: +49 21 73 8909 30

Hungary

Budapest

Tel: +36 13 39 8622

Fax: +36 13 39 8622

Italy

Parabiago

Tel: +390 331 49 3311

Fax: +390 331 49 3330

Europe, Middle East, Africa

Ecully, France

Tel: +33 472 18 2020

Fax: +33 472 18 2000

Netherlands

Breda

Tel: +351 76 578 3999

Fax: +31 76 578 3978

Poland

Warsaw

Tel: +48 22 843 3824

Fax: +48 22 843 3471

Portugal

Alfena

Tel: +351 229 69 8840

Fax: +351 229 69 8848

Lisbon

Tel: +351 212 109 340

Fax: +351 212 109 349

Russia

Moscow

Tel: +7 495 641 2359

Fax: +7 495 641 2358

U.A.E.

Dubai

Tel: +971 4 3381 861

Fax: +971 4 3382 343

U. K.

Middlesex

Tel: +44 1 895 43 0053

Fax: +44 1 895 45 9500

Sunderland

Tel: +44 191 522 2000

Fax: +44 191 522 2052

Asia – Pacific

Australia

Melbourne

Tel: +61 3 9 336 1300

Fax: +61 3 9 336 1322

Sydney

Tel: +61 2 9 896 4433

Fax: +61 2 9 896 3122

Asia – Pacific

Shanghai, China

Tel: +86 21 51113579

Fax: +86 21 51113578

Singapore

Tel: +65 6264 1188

Fax: +65 6862 4142

China

Beijing

Tel: +86 10 58674761

Fax: +86 10 58674760

Xi'an

Tel: +86 29 87891465

Fax: +86 29 87884504

Korea

Seoul

Tel: +82 2 3439 0400

Fax: +82 2 3439 0405

Philippines

Makati City

Tel: +63 2 844 9437

Fax: +63 2 844 4712

Factories

Brazil

Alphaville

China

Zhangjiagang

France

Charlieu

La Clayette

Moulins

Germany

Wilhelmshaven

India

Calcutta

Pune

Italy

Niella Tanaro

Portugal

Baltar

Fânzeres

Slovakia

Saris

U.S.A.

Manitowoc

Port Washington

Shady Grove

Constant improvement and engineering progress make it necessary that we reserve the right to make specification, equipment and price changes without notice. Illustrations shown may include optional equipment and accessories, and may not include all standard equipment.